

VISION / FILTRA VISION / FILTRA VISION+

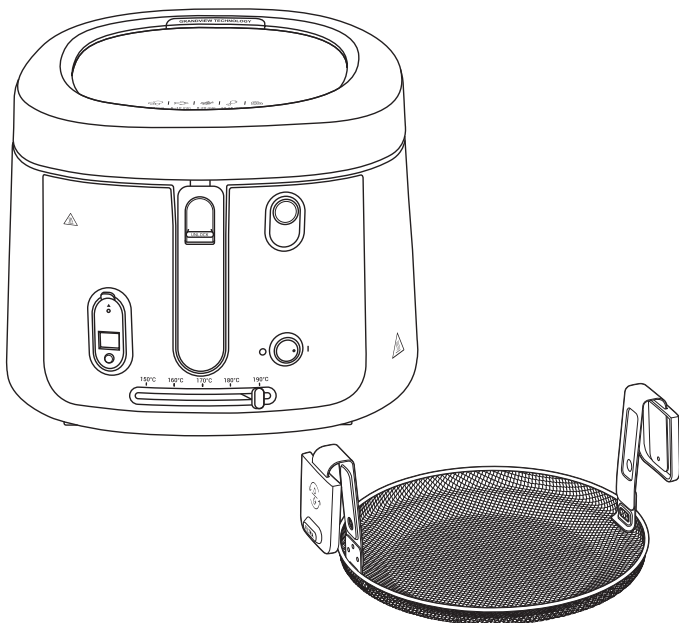

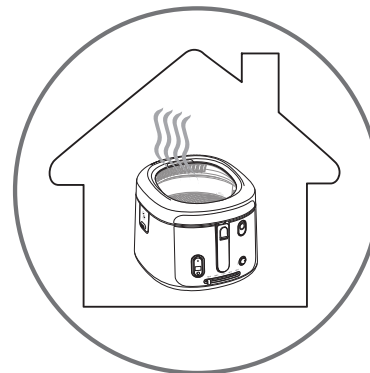

* Selon modèle • Afhankeljik van het model • Je nach Modell • Depending on model • Secondo i modelli • Segun modelo • Consoante o modelo • αυτόματα το μοντέλο • Modele göre • Afhængig af model • Beroende på modell • Avhenger av modell • Mallista riippuen • Ovisno o modelu • Zavisno od modela • в зависимости от модели • Odvisno od modela • W zależności od typu • Podle modelu • V závislosti od modelu • Modelltöl függően • В зависимости от модели • Залежно від моделі • Ovisno o modelu • Sõltuvalt mudelist • Atbilstoši modelim • Pagal modelį • بحسب النموذج • بحسب مدل • Në varësi të modelit • Во зависност од моделот

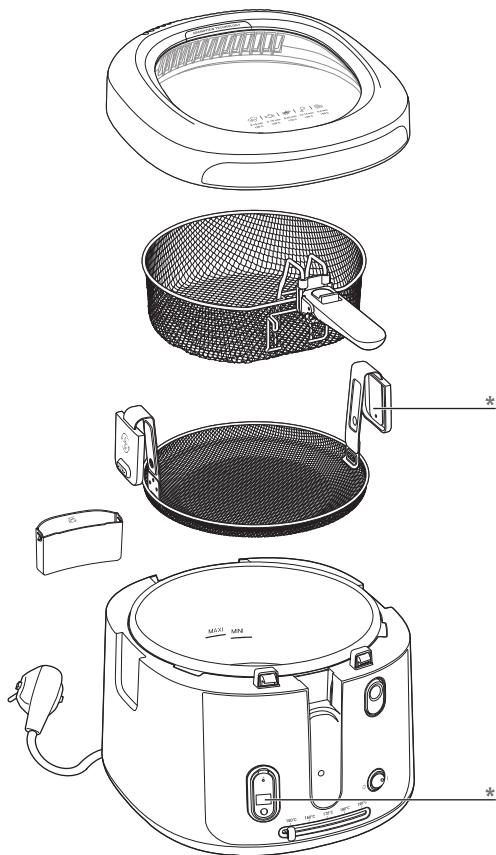

Min. 1,9 l
Max. 2,1 l

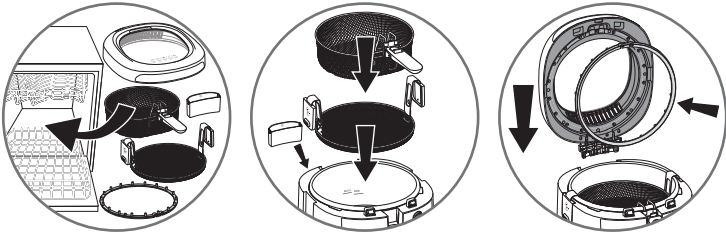
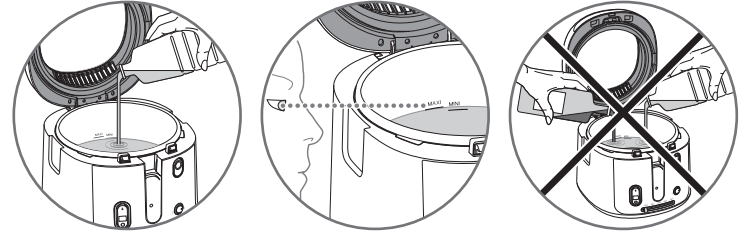
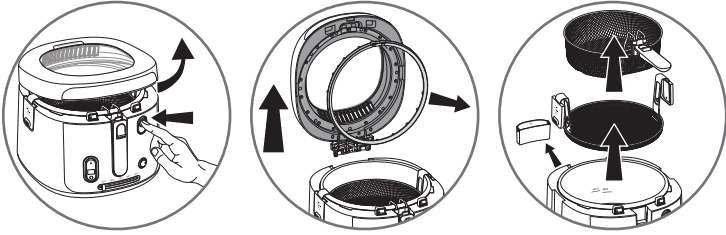

Min. 1660 g
Max. 1910 g

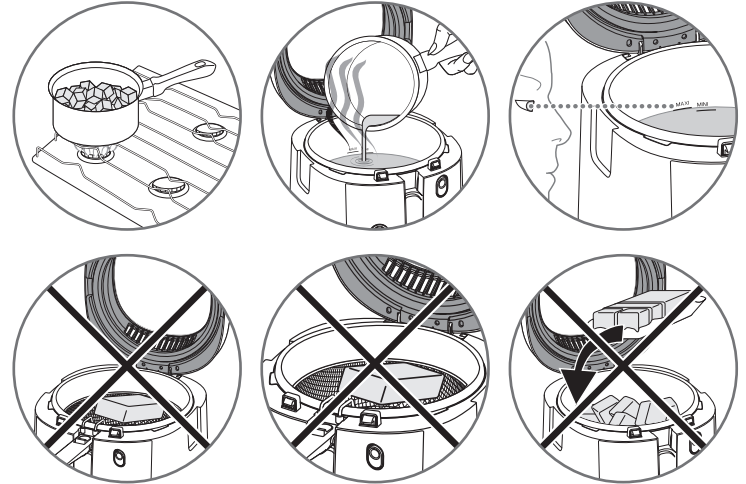



Max. 1200 g

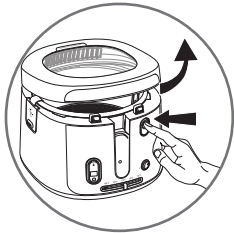
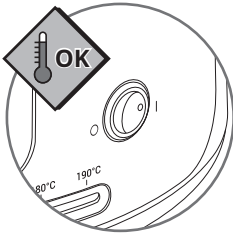
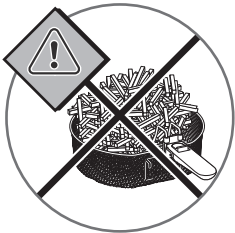
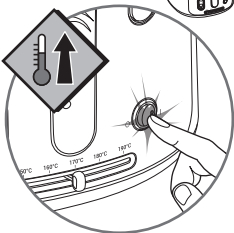
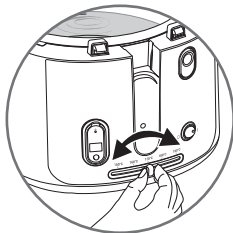
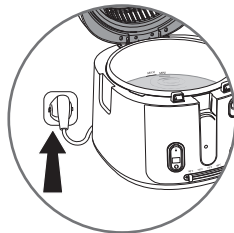
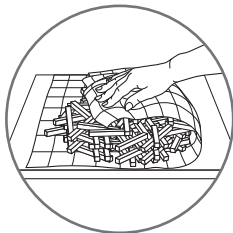

Max. 900 g

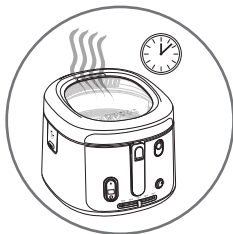
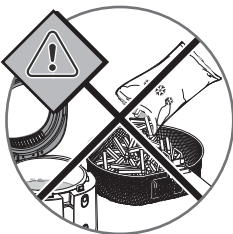
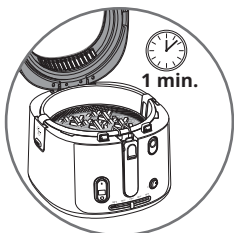
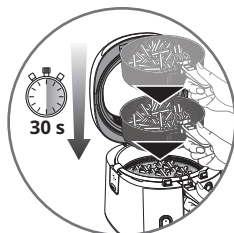
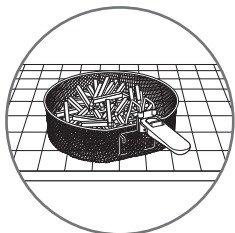
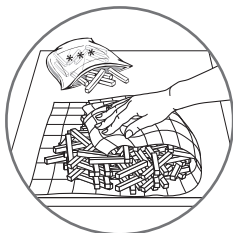

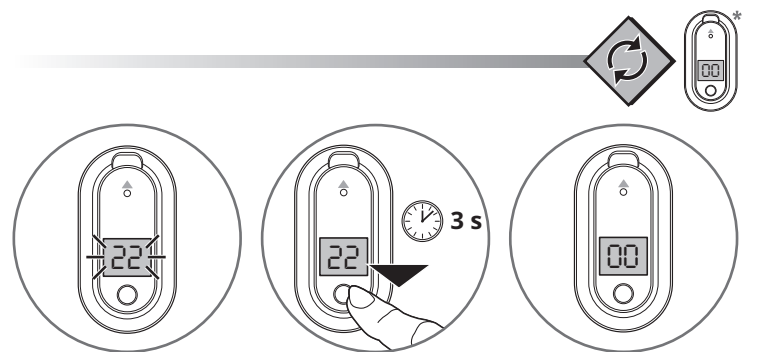
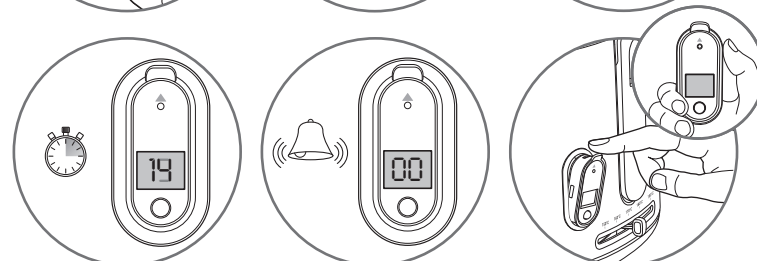
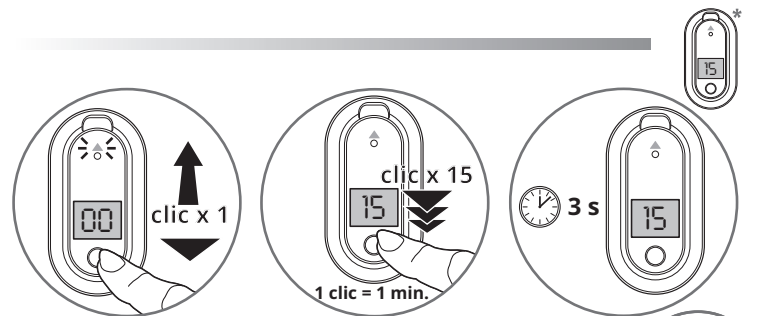
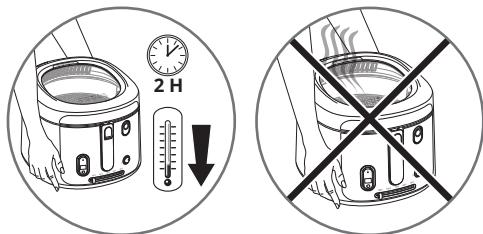
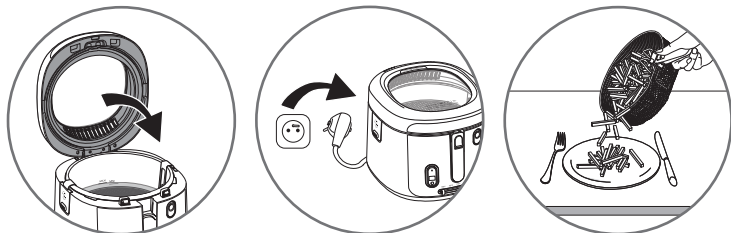
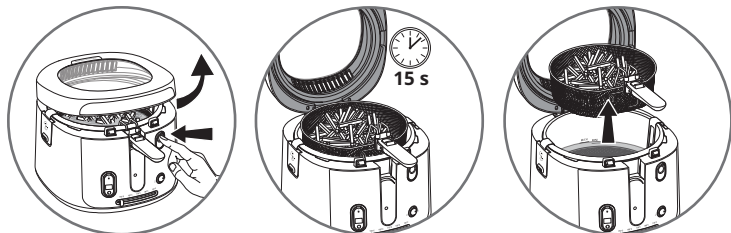
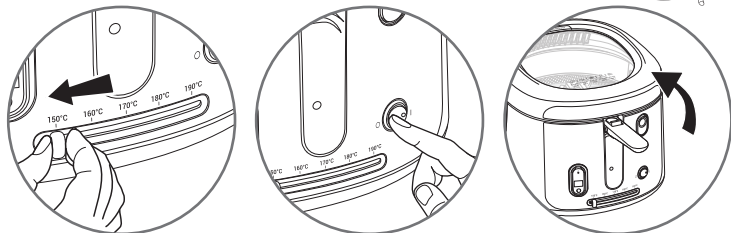

* Selon modèle • Afhankelijk van het model • Je nach Modell • Depending on model • Secondo i modelli • Según modelo • Consoante o modelo • ανάλογα με το μοντέλο • Modelle göre • Afhängig af model • Beroende på modellen • Avhenger av modell • Mallista riippuen • Ovisno o modelu • Zavisno od modela • в зависимости от модели • Ovisno od modela • W zależności od typu • Podle modelu • V závislosti od modelu • Modelltől függően • В зависимости от модели • Залежно від моделі • Ovisno o modelu • Sõltuvalt mudelist • Atbilstoši modelim • Pagal modelį • بحسب الموديل • بر حسب مدل • Në varësi të modelit • Во зависисот од моделот



	Nb			
		600 g	170°C	+/- 11-13 min
		1000 g	170°C	+/- 15-17 min
		1200 g	1 170°C 2 170°C	+/- 6-8 min +/- 10-12 min
	8		180°C	+/- 13-15 min
	3		170°C	+/- 6-8 min
		200 g	150°C	+/- 8-10 min
	7-8		180°C	+/- 8-10 min
	6		180°C	+/- 6-8 min
* * *	Nb			
		900 g	170°C	+/- 14-15 min
		750 g	170°C	+/- 9-11 min
		450 g	170°C	+/- 8-10 min
	10		190°C	+/- 6-8 min
	8		190°C	+/- 13-15 min
		900 g	190°C	+/- 7-8 min
		300 g	190°C	+/- 5-6 min

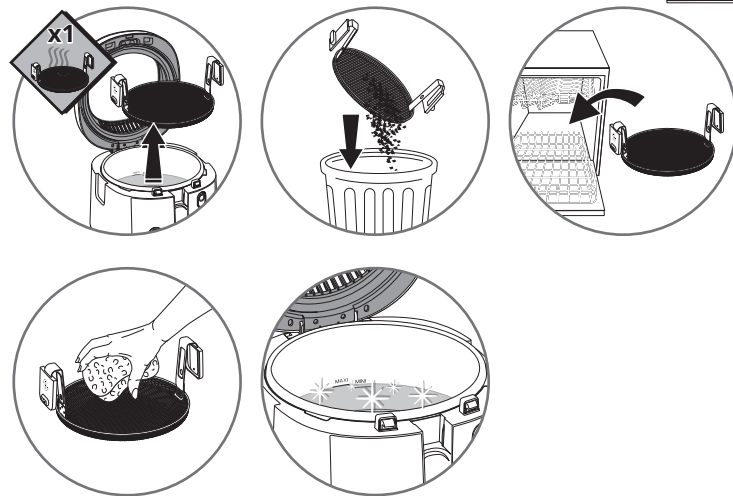

* Selon modèle • Afhankelijk van het model • Je nach Modell • Depending on model • Secondo i modelli • Según modelo • Consoante o modelo • ανάλογα με το μοντέλο • Modele göre • Afhängig af model • Beroende på modell • Avhenger av modell • Mallista riippuen • Ovisno o modelu • Zavisno od modela • в зависимость от модели • Ovisno od modela • W zależności od typu • Podle modelu • V závislosti od modelu • Modelltől függően • В зависимости от модели • Залежно від моделі • Ovisno o modelu • Sõltuvalt mudelist • Atbilstoši modelim • Pagal modelį • بر حسب مدل • بحسب النموذج • Në varësi të modelit • Во зависисот од моделот

